

- NOTES:
- A. FOR REFERENCE UNLESS PROPERLY ENDORSED. FOR ADDITIONAL DETAILS AND SPECIFICATIONS, CONSULT YASKAWA AMERICA, INC.
 - B. DIMENSIONS ARE IN INCHES[MILLIMETERS]
 - C. USE APPROPRIATE TYPE RATED HUBS OR FITTINGS TO MAINTAIN ENCLOSURE RATING.
 - D. HATCHED AREA INDICATES PERMISSIBLE CONDUIT ENTRANCE AREA.
 - E. FANS, FILTERS AND/OR CLOSING PLATES ARE SUPPLIED AS NEEDED PER OPTION SELECTIONS.

YASKAWA	ORIGINAL DESIGN: P. Johnson	DATE: 10/08/2019	TITLE: DIMENSION DRAWING, HV WM FP, 600, 3R, W4	
	DRAWN: P. Johnson	DATE: 10/09/2019	SIZE: A	REVISION: 03
<small>THIS DOCUMENT AND INFORMATION CONTAINED IN IT ARE CONFIDENTIAL AND CANNOT BE COPIED OR DISCLOSED IN WHOLE OR IN PART WITHOUT THE EXPRESS WRITTEN CONSENT OF YASKAWA AMERICA, INC.</small>	CHECKED: D. Guckenberger	DATE: 10/11/2019	PAGE: 1 OF 3	
UNITS: INCHES	SCALE: NONE	APPROVED: K. Flierl	DATE: 10/14/2019	DRAWING #: DD.HWF.3R.W4.01

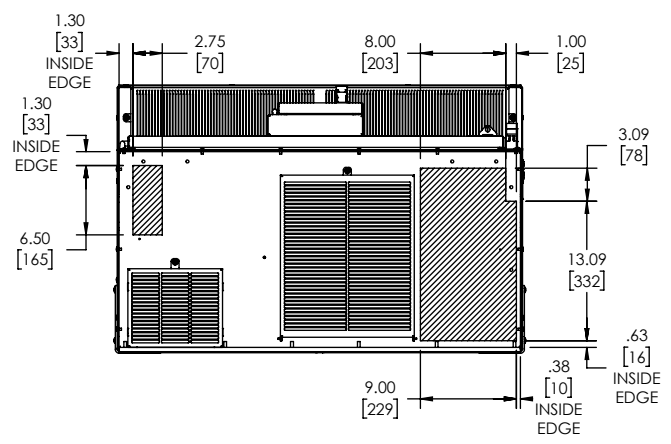

	ORIGINAL DESIGN: P. Johnson	DATE: 10/08/2019	TITLE: DIMENSION DRAWING, HV WM FP, 600, 3R, W4		
	DRAWN: P. Johnson	DATE: 10/09/2019	SIZE: A	REVISION: 03	PAGE: 2 OF 3
<small>THIS DOCUMENT AND INFORMATION CONTAINED IN IT ARE CONFIDENTIAL AND CANNOT BE COPIED OR DISCLOSED IN WHOLE OR IN PART WITHOUT THE EXPRESS WRITTEN CONSENT OF YASKAWA AMERICA INC.</small>		CHECKED: D. Guckenberger	DATE: 10/11/2019	DRAWING #:	
UNITS: INCHES	SCALE: NONE	APPROVED: K. Flierl	DATE: 10/14/2019	DD.HWF.3R.W4.01	

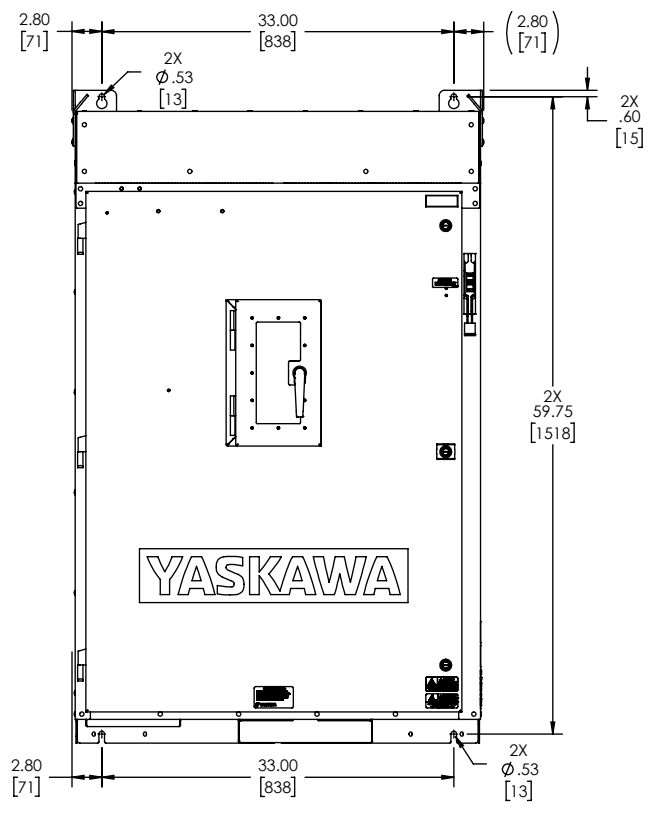
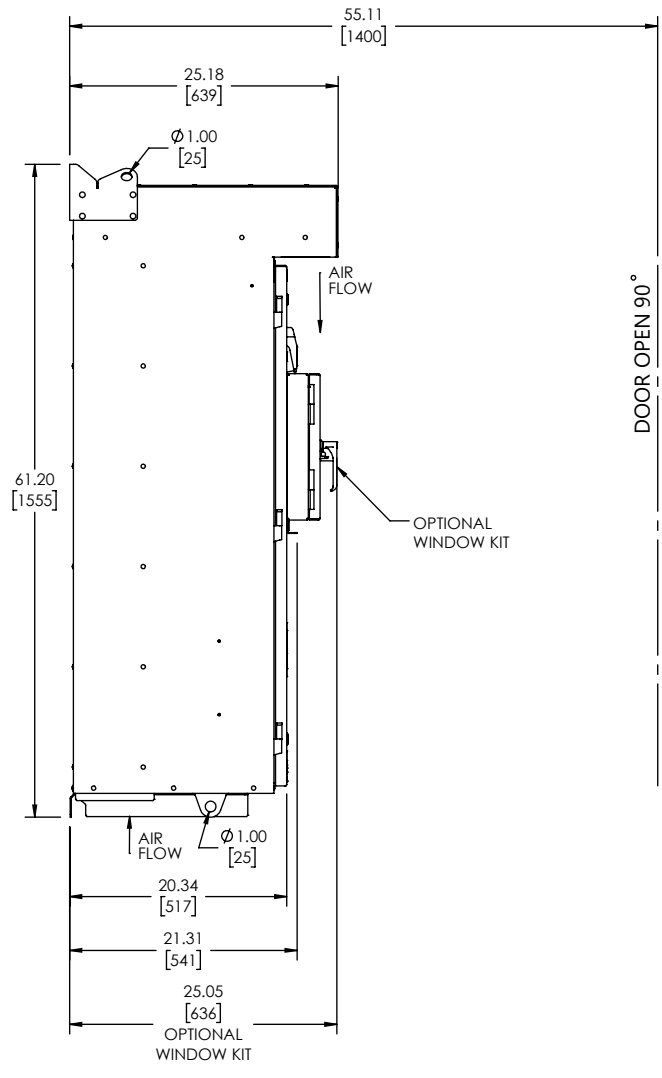
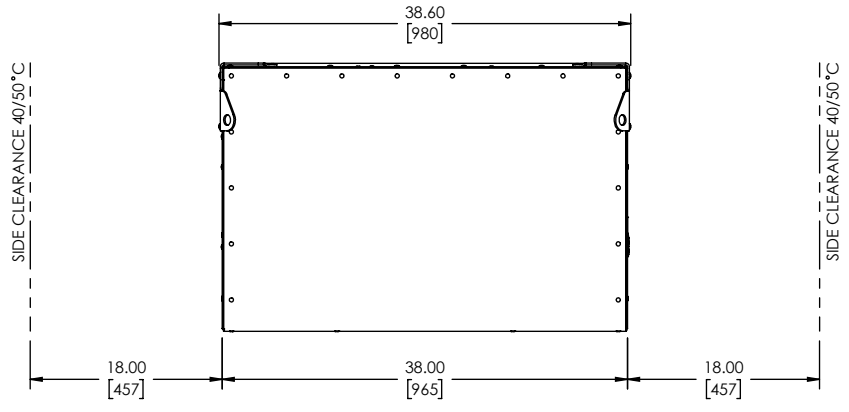
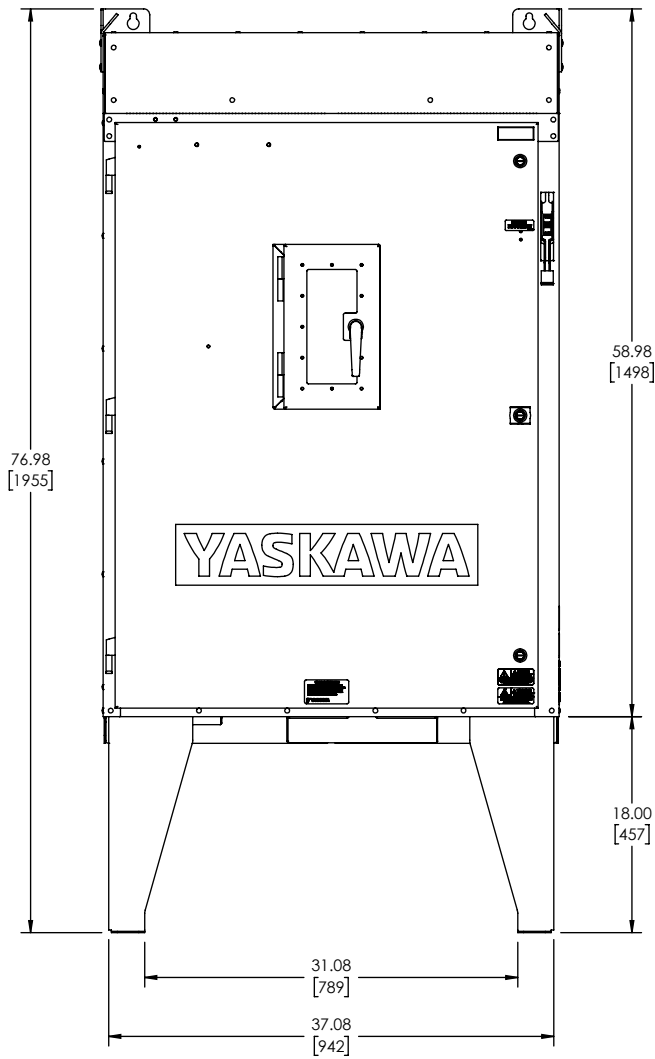

18" HIGH LEGS

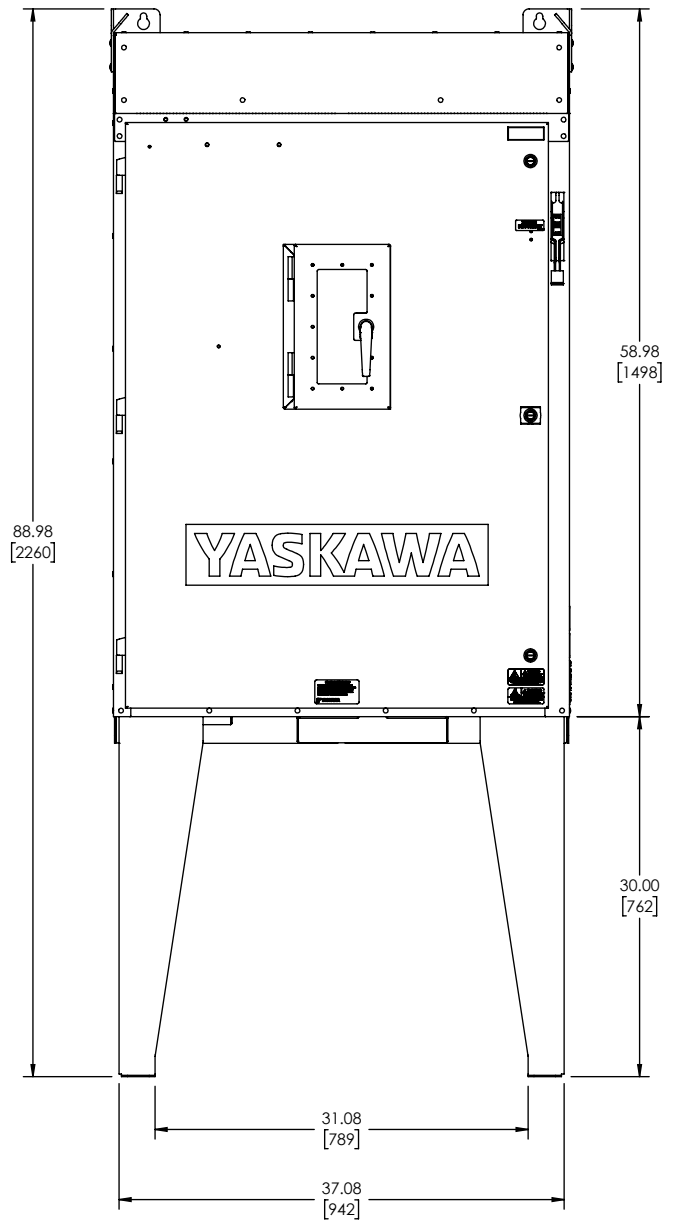

30" HIGH LEGS

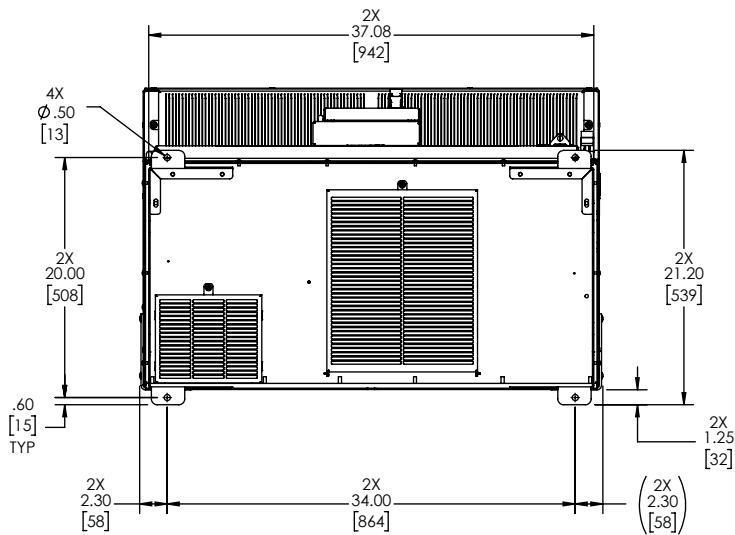

NOTE: DRILL PATTERN IS THE SAME FOR 18" AND 30" HIGH LEGS

YASKAWA

THIS DOCUMENT AND INFORMATION CONTAINED IN IT ARE CONFIDENTIAL AND CANNOT BE COPIED OR DISCLOSED IN WHOLE OR IN PART WITHOUT THE EXPRESS WRITTEN CONSENT OF YASKAWA AMERICA, INC.

UNITS: INCHES

SCALE: NONE

ORIGINAL DESIGN:
P. Johnson

DRAWN:
P. Johnson

CHECKED:
D. Guckenberger

APPROVED:
K. Flierl

DATE:
10/08/2019

DATE:
10/09/2019

DATE:
10/11/2019

DATE:
10/14/2019

TITLE:
**DIMENSION DRAWING, HV
WM FP, 600, 3R, W4**

SIZE:
A

REVISION:
03

PAGE:
3 OF 3

DRAWING #:

DD.HWF.3R.W4.01